

# B 400 relay - Safety critical, 4 contacts

## Datasheet

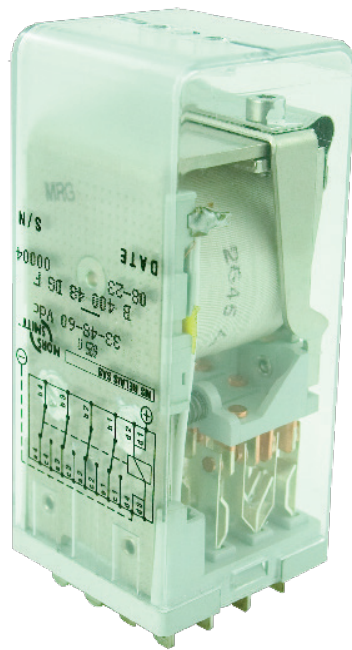

### Description

The B 400 safety critical and heavy duty relay has 4 double make / double break C/O contacts (form Z). Weld no transfer safety contacts are standard. The plug-in design offers secure locking feature for maximum ease of maintenance (no wires need to be disconnected or other hardware removed for relay inspection or replacement).

The resistance to impact and vibration is conforming the standards for Railway Transported Equipment. Positive mechanical keying of relay to socket is built into relay and socket during manufacture and terminal identifications are clearly marked on identification plate that is permanently attached to the relay.

### Application

The B 400 relay is designed for ultra reliable heavy duty and safety critical applications such as door control, emergency brake failure, interlocking between traction and breaking around the world in countless railcars.

#### Features

- Instantaneous & safety critical relay
- Plug-in design with secure locking feature for maximum ease of maintenance
- 4 double make / double break C/O contacts (form Z), 12 A
- Weld no transfer contacts standard
- Contact life (mechanical) of 100 million cycles
- -40 °C...+80 °C operating temperature

#### Benefits

- Proven reliable in heavy duty application
- Long life cycle
- Easy to maintain and replace
- Used in safety critical operation
- Low life cycle cost
- No maintenance

#### Railway compliancy

- NF F 62-002 Rolling stock - Instantaneous relays contacts and sockets
- NF F16-101/102 Fire behaviour - Railway rolling stock



# B 400 relay

## Technical specifications



### Functional and connection diagrams

Timing diagram	Relay pin correspondence																																					
	<p><b>Relay pin correspondence</b></p> <p>Example: BG keying</p> <table border="1"> <tr> <td>1</td> <td>2</td> <td>3</td> <td>4</td> </tr> <tr> <td>a</td> <td>R</td> <td>S</td> <td>K</td> </tr> <tr> <td>b</td> <td>P</td> <td>T</td> <td>J</td> </tr> <tr> <td>c</td> <td>O</td> <td>N</td> <td>H</td> </tr> <tr> <td>d</td> <td>D</td> <td>E</td> <td>L</td> </tr> <tr> <td></td> <td>C</td> <td>F</td> <td>M</td> </tr> <tr> <td></td> <td>B</td> <td>V</td> <td>G</td> </tr> <tr> <td></td> <td>A</td> <td>W</td> <td>Y</td> </tr> <tr> <td></td> <td></td> <td>U</td> <td>Z</td> </tr> </table> <p>(rear view of relay shown)</p>	1	2	3	4	a	R	S	K	b	P	T	J	c	O	N	H	d	D	E	L		C	F	M		B	V	G		A	W	Y			U	Z	<p><b>Led (V) option</b> (respect polarity)</p> <p>N.B.1 : On 500VDC and 700VDC relays, coil is connected only to D1 and D4. D2 and D3 are not wired and transil or diode protections are not available.</p> <p>N.B.2 : Transil not needed on VAC coil relays</p>
1	2	3	4																																			
a	R	S	K																																			
b	P	T	J																																			
c	O	N	H																																			
d	D	E	L																																			
	C	F	M																																			
	B	V	G																																			
	A	W	Y																																			
		U	Z																																			
Connection diagram																																						
<p><b>VDC Models</b> (no Transil protection)</p>	<p><b>VDC Models</b> (with Transil protection)</p>	<p><b>VAC Models</b> N.B.: Transil not needed on VAC coil relays.</p>																																				



# B 400 relay

## Technical specifications

### Coil data - DC versions

Keying	Unom (VDC)	Uoperating (VDC)	Pnom (W)	Uhold (VDC)	Udrop-out (VDC)	R coil ( $\Omega$ ) <sup>(1)</sup>	L/R (ms) <sup>(2)</sup>
ME	12	8 / 16	3.5	6.25	1.25	40	40
AG	24	16 / 33	3.5	13.5	2.5	170	40
FL	36	25 / 45	3.5	21	3.5	390	40
DG	48	33 / 60	3.5	28.5	4.5	625	40
BG	72	48 / 90	3.5	40.5	6.5	1600	40
US	96	65 / 120	3.8	50	9	2400	40
EG	115	77 / 144	3.5	60	11.5	4000	40
FG	550	440 / 660	4	300	50	75500	40
UT	700	450 / 900	4.2	380	60	115000	40

(1) Coil resistance tol.:  $\pm 8\%$  at 20 °C

(2) Valid for closed relay

### Coil data - AC versions

Keying	Unom (VAC)	Uoperating (VAC)	Pnom (VA)	Uhold (VAC)	Udrop-out (VAC)	R coil ( $\Omega$ ) <sup>(1)</sup>	L/R (ms) <sup>(2)</sup>
EM	127	88 / 143	4	71.5	12	4000	40
CG	220	176 / 242	3	129	21	14350	30

(1) Coil resistance tol.:  $\pm 8\%$  at 20 °C

(2) Valid for closed relay

### Contact data – standard version (Ag contacts)

Nominal current	12 A resistive		
Nominal breaking capacity and life	3 A at 72 VDC		L/R : 0 ms Electrical life: 5 x 10 <sup>6</sup> op.
	1 A at 72 VDC		L/R: 30 ms Electrical life: 2.5 x 10 <sup>6</sup> op.
	3 A at 220 VAC 50 Hz		cos $\phi$ =1 Electrical life: 2.5 x 10 <sup>6</sup> op.
	Lamp filament circuit: 200 W at 72 VDC		Electrical life: 5 x 10 <sup>5</sup> op.
Contact overload withstand	At 24 VDC: 200 A at L/R = 0 for 10 ms (10 operations at the rate of 1 operation per minute)		
Contact closure time	Pick-up time N/O < 55 ms		Drop-out* time N/C < 25 ms
Contact opening time	Pick-up time N/C < 50 ms		Drop-out* time N/O < 15 ms
Minimum contact continuity	20 mA at 24 VDC		
Number of contacts	4 double make / double break contacts (form Z)		
Contact material	Hard silver overlay laminated to copper		
Contact resistance	initial	10 m $\Omega$ max at 5 A	
	end of life	40 m $\Omega$ max at 5 A	



# B 400 relay

## Technical specifications

### Contact design

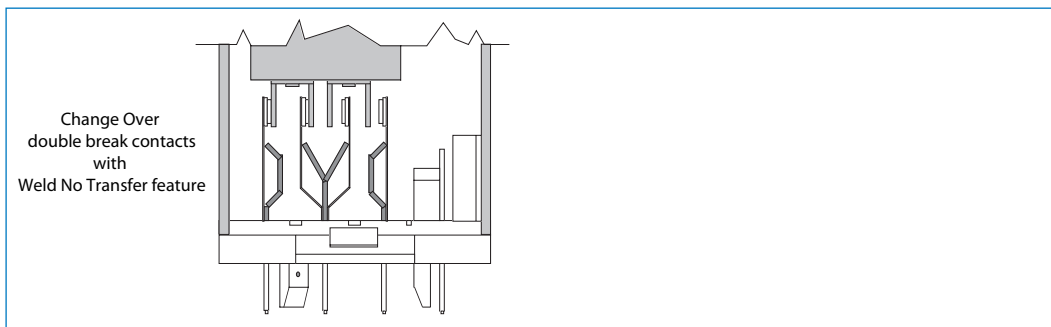

### Electrical characteristics

Dielectric strength	2000 VAC, 1 min between contacts 2600 VAC, 1 min between contacts, coil and frame
Insulation resistance	≥ 1000 MΩ at 500 VDC

### Mechanical & environmental characteristics

Vibration	NF F 62-002 The tests are conducted in the X, Y, Z planes at frequency between 10 & 150 cycles (sinusoidal) at 2 g
Shock	NF F 62-002 Tests are applied in both directions in the X, Y & Z planes. Then successive shocks are administered consisting of the positive component of sinusoidal with a value of 30 g, 18 ms Other vibration and shock tests can be performed on request.
Mechanical life	> 100 x 10 <sup>6</sup> operations
Weight	450 g
Temperature	-40 °C...+80 °C
Humidity	93% RH, 40 °C for 4 days
Salt mist	5% NaCl, 35 °C for 4 days
Protection	IP40
Fire & smoke	Materials: Polycarbonate (cover) / polyester melamine (base) Note: These materials have been tested for fire propagation and smoke emission according standards NF F 16-101, NF F 16-102, ASTM E162 and ASTM E662, and have been approved to be used on the English/French train channel shuttle.



# B 400 relay

## Technical specifications

### Dimensions (mm)

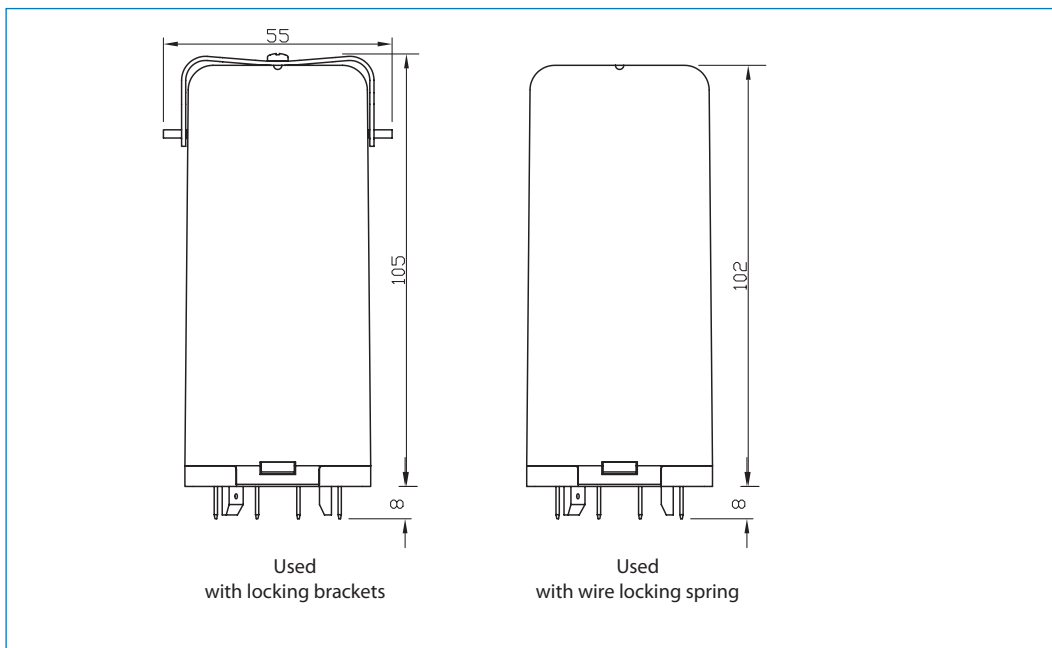

### Keying

Socket (Top view)  
keyd for BG (72V DC)

Round Plug      Hexagonal key (typical)

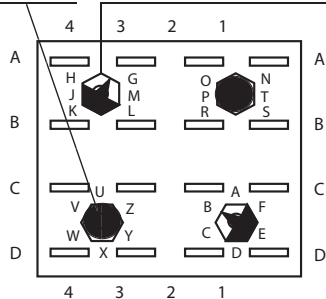

Keying of relay to socket is accomplished by pressing 2 hexagonal keys and 2 round plugs into molded-in recesses on the socket.

Relay keying done in factory.

Insert keys so that arrows point to the correct keying letters on socket - see example shown.

Faston socket EA 104 shown. Screw type socket EA 103, front single faston EA 105 and double Faston EA 102 are keyed similarly.

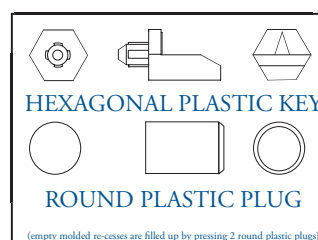

# B 400 relay

## Technical specifications

### Dynamic relay selection curve

**AC Current breaking capacity versus life expectancy in millions of cycles.**

Rate of contacts opening and closing = 1200 operations per hour.

Curves shown for resistive load (Power Factor = 1).

Curve	1	2	3	4
VAC	220	125	48	24

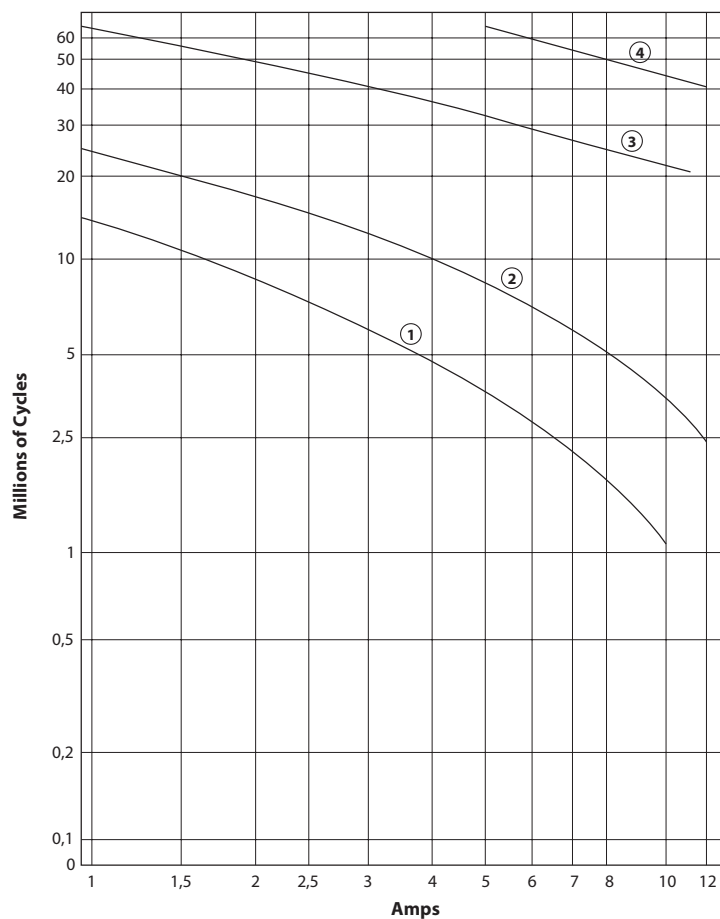

# B 400 relay

## Technical specifications

### Dynamic relay selection curve 2

DC Current breaking capacity versus life expectancy in millions of cycles.

Rate of contacts opening and closing = 1200 operations per hour.

Curves shown for inductive load -

—— L/R= 20 ms continuous current

- - - - L/R= 40 ms continuous current

\* By connecting 2 contacts in series, DC current breaking capacity increases by 50 %

Curves	1-3	2-4	5-7	6-8
VDC	220	125	48	24

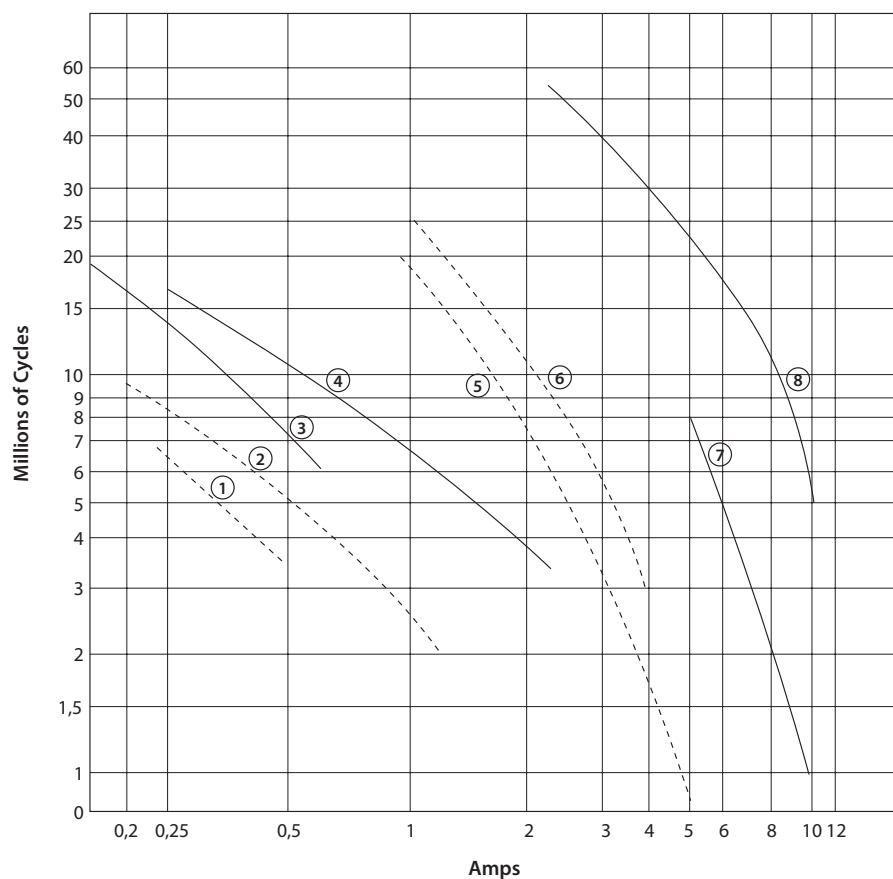

# B 400 relay

## Technical specifications

### Dynamic relay selection curve 3

**DC Current breaking capacity versus life expectancy in millions of cycles.**

Rate of contacts opening and closing = 1200 operations per hour.

Curves shown for resistive load (L/R = 0). Continuous current.

\* By connecting 2 contacts in series, DC current breaking capacity increases by 50 %

Curve	1	2	3	4
VDC	220	125	48	24

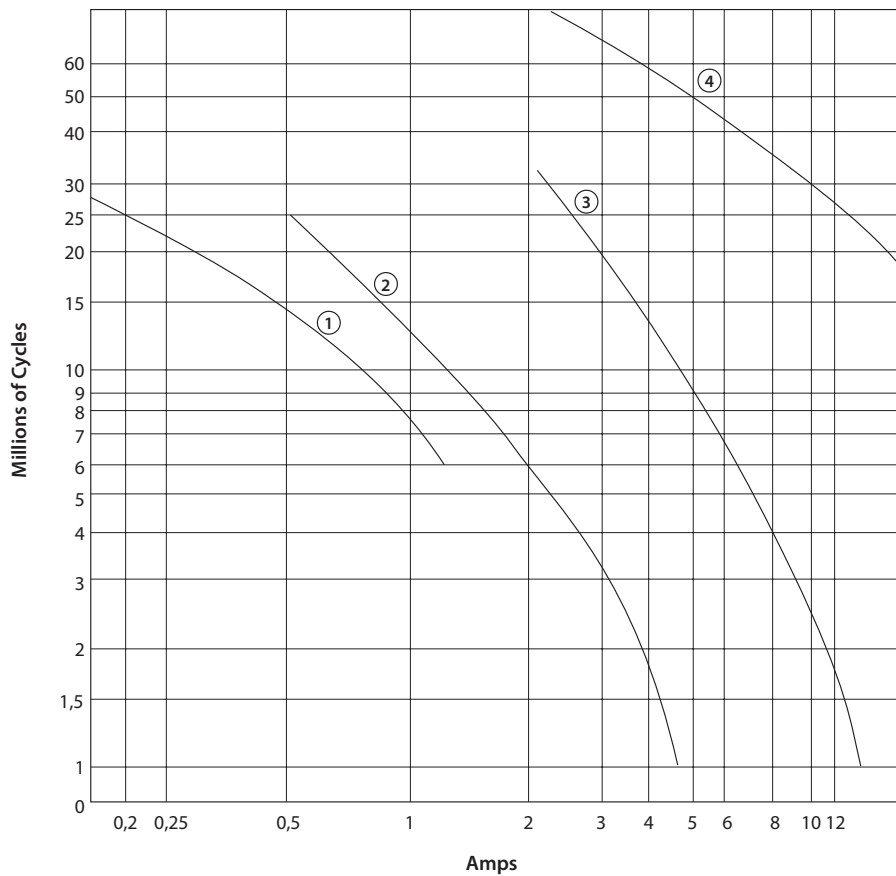



# B 400 relay

## Technical specifications

### Dynamic relay selection curve 4

**Maximum contact breaking capacity versus voltage for a given L/R.**

Rate of contacts opening and closing = 600 operations per hour.

Curves shown for resistive load (L/R=0) and inductive loads. Continuous current.

Life expectancy: 2 Millions of Cycles

Curve	1	2	3	4	5	6
L/R=	0ms	15ms	20ms	40ms	60ms	100ms

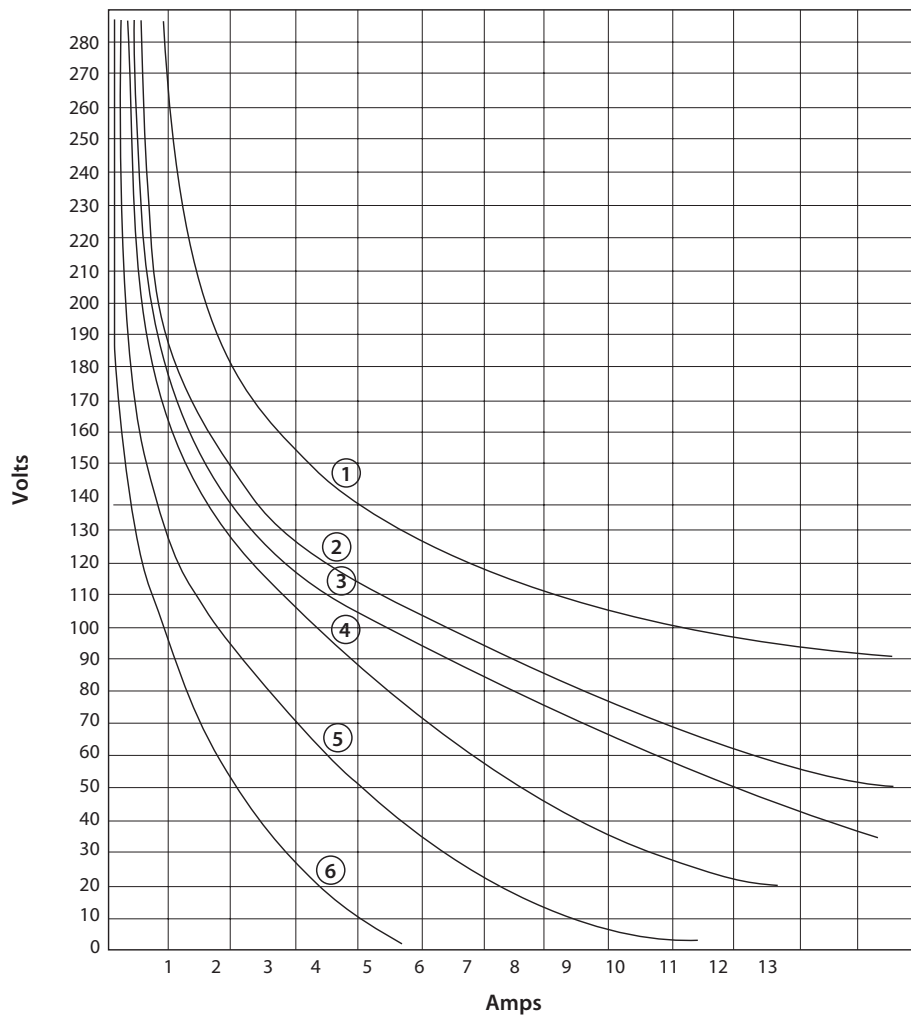

# B 400 relay

## Technical specifications

### Dynamic relay selection curve 5

Maximum power interruption versus load time constant (L/R) for a given voltage.  
Curves shown for resistive loads.  $I = P/V$ .

Curve	1	2	3	4	5
VDC	220	125	72	48	24

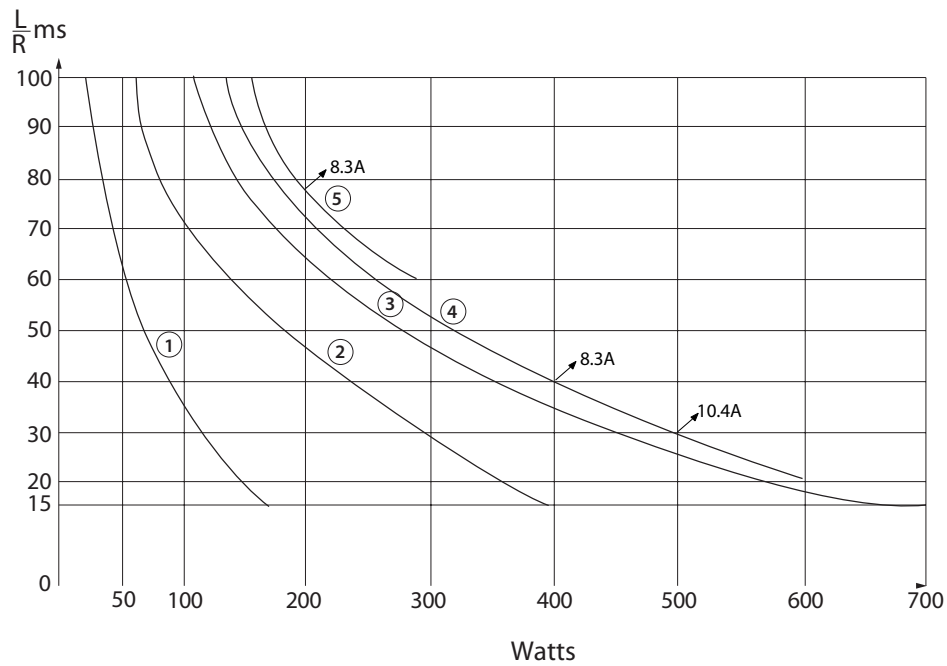

# B 400 relay

## Technical specifications

### Dynamic relay selection curve 6

AC Current breaking capacity versus life expectancy in millions of cycles.

Rate of contacts opening and closing = 1200 operations per hour.

Values shown for inductive loads -

——— Cos  $\phi$  = 0.7

- - - - Cos  $\phi$  = 0.5

- - - - Cos  $\phi$  = 0.3

Curves	1,3 &5	2,4 &7	6,9 &10	8,11 &12
VAC	220	125	48	24

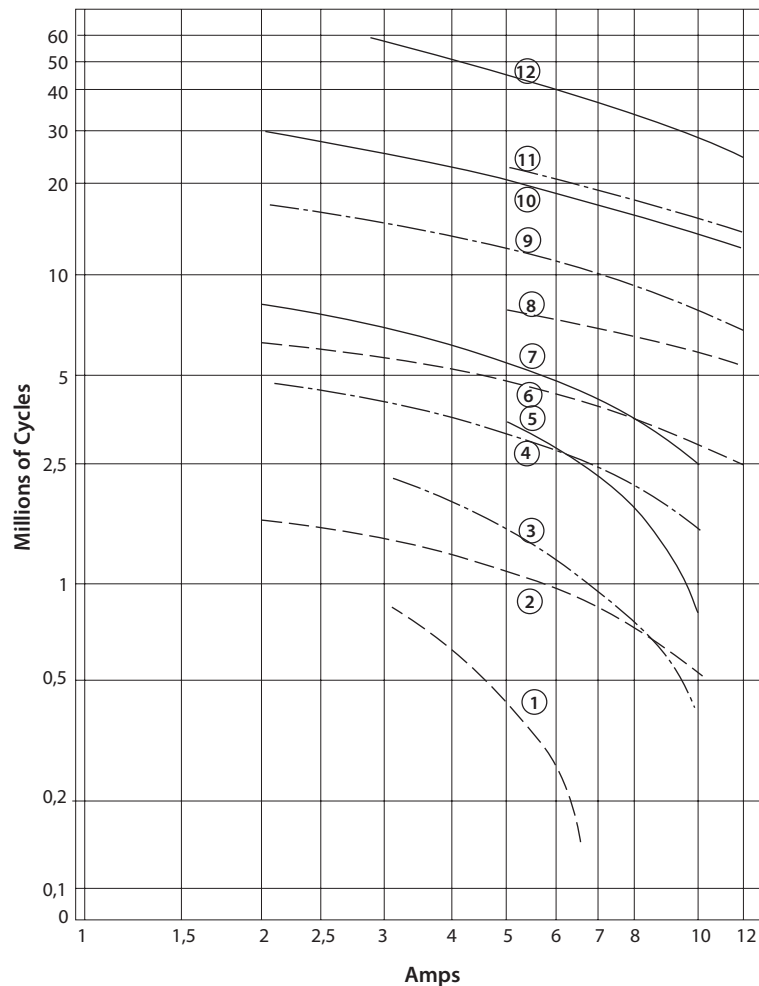

# B 400 relay

## Mounting possibilities

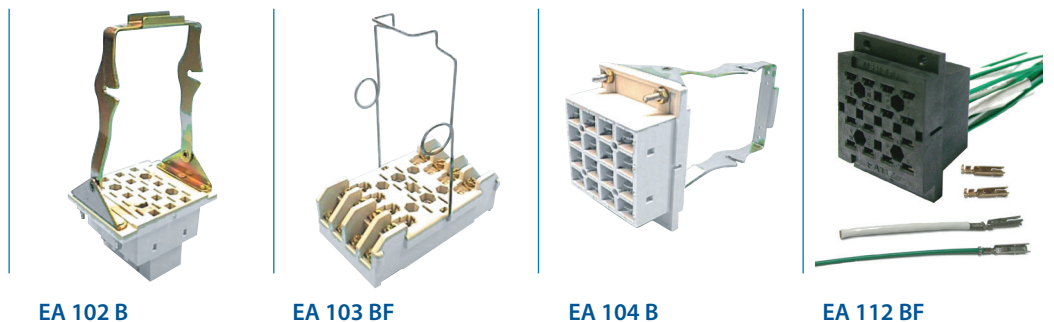

## Mounting possibilities / sockets

### Panel/flush mounting

EA 102 B	Locking bracket (905843), rear connection, double Faston 5 mm.
EA 102 BF	Wire locking spring (926853), rear connection, single Faston 5 mm.
EA 104 B	Locking bracket (905843), rear connection, single Faston 5 x 0.8 mm.
EA 104 BF	Wire locking spring (926853), rear connection, single Faston 5 x 0.8 mm
EA 112 BF	Wire locking spring (926853), rear connection, crimp contact

### Surface/wall mounting

EA 103 BF*	Wire locking spring (926853), front connection, M3 screw 6.5 mm. ring terminals (2.5 mm <sup>2</sup> )
EA 105 BF*	Wire locking spring (926853), front connection, single Faston 5 mm

\* Mounting possibility on 35 mm rail EN 50022 by adding suffix D to the part number (see socket datasheet)









Note: Keying of relay to socket can be specified by adding the keying letters in the part number. See all details in the related socket datasheet.

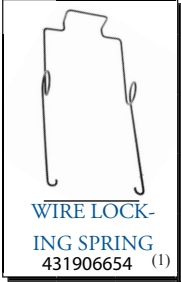

# B 400 relay

## Spare parts

### Spare parts - ordering codes

 <p>LOCKING BRACKET</p> <p>905846 (1)</p>	 <p>SCREW FOR BRACKET</p> <p>C927210 (1)</p>	 <p>METAL STRAP (2)</p> <p>P928060 (1)</p>	 <p>METAL STRAP (4)</p> <p>P928061 (1)</p>
 <p>WIRE LOCK- ING SPRING</p> <p>431906654 (1)</p>	 <p>ROUND PLASTIC PLUGS</p> <p>414928005 (1)</p>	 <p>HEX. PLASTIC KEYS</p> <p>414905678 (2)</p>	 <p>LOCK PINS ASSY 2 SCREWS</p> <p>906364 212903020 (3)</p>

(1) Parts only for socket  
 (2) Parts for relay and socket  
 (3) Parts only for relay



# B 400 relay

## User specifications

### Installation

Install socket and connect wiring correctly according identification to terminals. Plug relay into socket. Reverse installation into socket is not possible due to mechanical blocking by snap-lock. Don't reverse polarity of coil connection. Relays can be mounted (tightly) next to each other and in any attitude. B400 relay can be mounted in any position. **Warning!** Never use silicon near relays.

### Operation

Before operating always apply voltage to coil to check correct operation.  
Long term storage may corrode the silver on the relay pins. Just by plugging the relay into the socket, the female bifurcated receivers will automatically clean the corrosion on the pins and guarantee a good connection.  
Do not use the relay in places with flammable gas as the arc generated from switching could ignite gasses.

### Maintenance

Correct operation of relay can easily be checked as transparent cover gives good visibility on the moving contacts. When the relay doesn't seem to operate correctly, please check presence of coil voltage. Use a multimeter. If LED is used, coil presence should be indicated. If coil voltage is present, but the relay doesn't work, a short circuit of suppression diode is possible (The coil connection was reversed). If relay doesn't work after inspection, please replace relay unit by a similar model. Send defective relay back to manufacturer. Normal wear and tear excluded.



# B 400 relay

## Ordering scheme



This example represents a **B 400 24 AG S C V F**

**Description:** B 400 series relay, Unom: 24 VDC, keying AG, transil coil protection, Weld no transfer, LED indicator, relay cover for wire locking spring

### 1. Relay model

**B 400**

### 2 & 3. Nominal voltage and keying

<b>ME</b>	12 VDC
<b>AG</b>	24 VDC
<b>FL</b>	36 VDC
<b>DG</b>	48 VDC
<b>BG</b>	72 VDC
<b>US</b>	96 VDC
<b>EG</b>	115 VDC
<b>FG</b>	550 VDC
<b>UT</b>	700 VDC
<b>EM</b>	127 VAC
<b>CG</b>	220 VAC

### 4. Coil overvoltage protection

-	No coil protection
<b>P</b>	Avalanche diode coil protection
<b>S</b>	Transil coil protection

Note: no protection for AC coil versions

### 5. LED coil voltage indicator

-	No LED
<b>V</b>	LED voltage indicator

### 6. Relay cover type

-	Relay cover with lock pins
<b>F</b>	Relay cover for wire locking spring



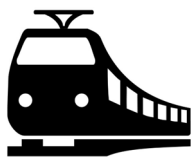

**Mors Smitt France SAS**

Tour Rosny 2, Avenue du Général de Gaulle,  
F - 93118 Rosny-sous-Bois Cedex, FRANCE  
T +33 (0)1 4812 1440, F +33 (0)1 4855 9001  
E [sales.msf@wabtec.com](mailto:sales.msf@wabtec.com)

**Mors Smitt Asia Ltd.**

29/F, Fun Towers, 35 Hung To Road  
Kwun Tong, Kowloon, HONG KONG SAR  
T +852 2343 5555, F +852 2343 6555  
E [sales.msa@wabtec.com](mailto:sales.msa@wabtec.com)

**Mors Smitt B.V.**

Vrieslantlaan 6, 3526 AA Utrecht,  
NETHERLANDS  
T +31 (0)30 288 1311, F +31 (0)30 289 8816  
E [sales.msbv@wabtec.com](mailto:sales.msbv@wabtec.com)

**Mors Smitt Technologies Inc.**

1010 Johnson Drive,  
Buffalo Grove, IL 60089-6918, USA  
T +1 847 777 6497, F +1 847 520 2222  
E [salesmst@wabtec.com](mailto:salesmst@wabtec.com)

**Mors Smitt UK Ltd.**

Graycar Business Park, Barton under Needwood,  
Burton on Trent, Staffordshire, DE13 8EN, UK  
T +44 (0)1283 722650 F +44 (0)1283 722651  
E [sales.msuk@wabtec.com](mailto:sales.msuk@wabtec.com)

**RMS Mors Smitt**

6 Anzed Court, Mulgrave,  
VIC 3170, AUSTRALIA  
T +61 (0)3 8544 1200 F +61 (0)3 8544 1201  
E [sales.rms@wabtec.com](mailto:sales.rms@wabtec.com)